

Dell™ ST2420L/ST2421L monitor User's Guide

[About Your Monitor](#)



[Setting Up the Monitor](#)

[Operating the Monitor](#)

[Solving Problems](#)

[Appendix](#)

Notes, Notices, and Cautions

-  **NOTE:** A NOTE indicates important information that helps you make better use of your computer.
 -  **NOTICE:** A NOTICE indicates either potential damage to hardware or loss of data and tells you how to avoid the problem.
 -  **CAUTION:** A CAUTION indicates a potential for property damage, personal injury, or death.
-

Information in this document is subject to change without notice.
© 2010 Dell™ Inc. All rights reserved.

Reproduction of these materials in any manner whatsoever without the written permission of Dell Inc. is strictly forbidden.

Trademarks used in this text: *Dell* and the *DELL* logo are trademarks of Dell Inc. *Microsoft* and *Windows* are either trademarks or registered trademarks of Microsoft Corporation in the United States and/or other countries; *ENERGY STAR* is a registered trademark of the U.S. Environmental Protection Agency. As an ENERGY STAR partner, Dell Inc. has determined that this product meets the ENERGY STAR guidelines for energy efficiency.

Other trademarks and trade names may be used in this document to refer to either the entities claiming the marks and names or their products. Dell Inc. disclaims any proprietary interest in trademarks and trade names other than its own.

ST2420Lb/ST2421Lb

August 2010 Rev. A00

[Back to Contents Page](#)

About Your Monitor

Dell™ ST2420L/ST2421L monitor User's Guide

- [Package Contents](#)
- [Product Features](#)
- [Identifying Parts and Controls](#)
- [Monitor Specifications](#)
- [Plug and Play Capability](#)
- [LCD Monitor Quality & Pixel Policy](#)
- [Maintenance Guidelines](#)

Package Contents

Your monitor ships with the components shown below. Ensure that you have received all the components and [contact Dell](#) if something is missing.

 **NOTE:** Some items may be optional and may not ship with your Monitor. Some features or media may not be available in certain countries.

	1 Monitor with Stand
	1 Power Cable
	1 DVI Cable (optional)
	1 VGA Cable

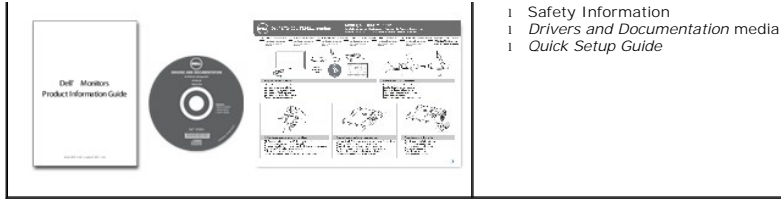

Product Features

The **ST2420L/ST2421L** flat panel display has an active matrix, Thin-Film Transistor (TFT), and Liquid Crystal Display (LCD). The monitor features include:

- **ST2420L/ST2421L**: 60.97cm (24 inches) viewable area display.
- 1920 x 1080 resolution, plus full-screen support for lower resolutions.
- Tilt adjustment capability.
- Plug and play capability if supported by your system.
- On-Screen Display (OSD) adjustments for ease of set-up and screen optimization.
- Software and documentation CD which includes an information file (INF), Image Color Matching File (ICM), and product documentation.
- Energy Saver feature for Energy Star compliance.
- Security lock slot.

Identifying Parts and Features

Front View



Front View

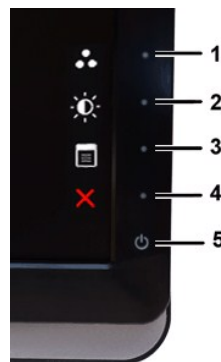

Front Panel Controls

Label	Description
1-2	Shortcut keys
	*The default settings are Preset Modes and Brightness/Contrast.
1	Shortcut key: Preset Modes (Default)
2	Shortcut key: Brightness/Contrast (Default)
3	OSD menu select
4	EXIT
5	Power On/Off (light indicator below Dell logo)

Back View



Back View

	Label	Description/Use
1	Barcode serial number label	To contact Dell for technical support.
2	Security lock slot	To help secure your monitor.
3	Dell Soundbar mounting brackets	To attach the optional Dell Soundbar.
4	Regulatory rating label	Lists the regulatory approvals.
5	Stand release button	To release stand assembly from monitor.

Side View







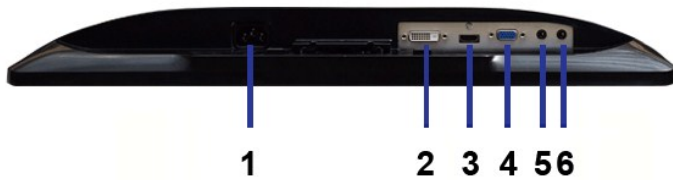

Left Side

Bottom View



Bottom view

Label	Description
1 	AC power cord connector
2 	DVI connector
3 	HDMI connector
4 	VGA connector
5 	Audio Line-in
6 	Audio Line out

Monitor Specifications

Power Management Modes

If you have VESA's DPMS™ compliance display card or software installed in your PC, the monitor can automatically reduce its power consumption when not in use. This is referred to as Power Save Mode. If input from a keyboard, mouse or other input devices is detected by the computer, the monitor will automatically "wake up". The following table shows the power consumption and signaling of this automatic power-saving feature:

ST2420L/ST2421L

VESA Modes	Horizontal Sync	Vertical Sync	Video	Power Indicator	Power Consumption
Normal operation	Active	Active	Active	White	30 W (maximum) 20 W (typical)
Active-off mode	Inactive	Inactive	Blanked	Amber	Less than 1 W
Switch off	-	-	-	Off	Less than 0.5 W

 **NOTE:** This monitor is ENERGY STAR®-compliant.



 **NOTE:** Zero power consumption in OFF mode can only be achieved by disconnecting the main cable from the monitor.

Pin Assignments

VGA Connector

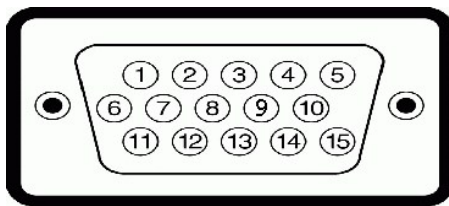

Pin Number	15-pin Side of the Connected Signal Cable

1	Video-Red
2	Video-Green
3	Video-Blue
4	GND
5	Self-test
6	GND-R
7	GND-G
8	GND-B
9	Computer 5V/3.3V
10	GND-sync
11	GND
12	DDC data
13	H-sync
14	V-sync
15	DDC clock

DVI Connector

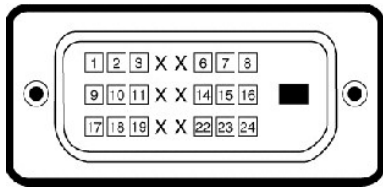

Pin Number	24-pin Side of the Connected Signal Cable
1	TMDS RX2-
2	TMDS RX2+
3	TMDS Ground
4	Floating
5	Floating
6	DDC Clock
7	DDC Data
8	Floating
9	TMDS RX1-
10	TMDS RX1+
11	TMDS Ground
12	Floating
13	Floating
14	+5V power
15	Self test
16	Hot Plug Detect
17	TMDS RX0-
18	TMDS RX0+
19	TMDS Ground
20	Floating
21	Floating
22	TMDS Ground
23	TMDS Clock+
24	TMDS Clock-

HDMI Connector

Pin Number	19-pin Side of the Connected Signal Cable
1	TMDS DATA 2+
2	TMDS DATA 2 SHIELD
3	TMDS DATA 2-
4	TMDS DATA 1+
5	TMDS DATA 1 SHIELD
6	TMDS DATA 1-
7	TMDS DATA 0+
8	TMDS DATA 0 SHIELD
9	TMDS DATA 0-
10	TMDS CLOCK
11	TMDS CLOCK SHIELD
12	TMDS CLOCK-
13	CEC
14	Reserved (N.C. on device)
15	DDC CLOCK (SCL)
16	DDC DATA (SDA)
17	DDC/CEC Ground
18	+5V POWER
19	HOT PLUG DETECT

Flat Panel Specifications

Model	ST2420L/ST2421L
Screen type	Active matrix - TFT LCD
Panel type	TN
Screen dimensions	60.97cm (24 inches) (24-inch viewable image size)
Preset display area:	
Horizontal	531.36 mm (20.92 inches)
Vertical	298.89 mm (11.77 inches)
Pixel pitch	0.277 mm
Viewing angle	160° (vertical) typical, 170° (horizontal) typical
Luminance output	250 CD/m ² (typical)
Contrast Ratio	1,000:1 (typical)
Dynamic Contrast Ratio	ST2420L: 8,000,000 to 1* ST2421L: 7,000,000 to 1*
Faceplate coating	Antiglare with hard-coating 3H
Backlight	LED light bar system
Response Time	5 ms typical
Color Depth	16.7 mil colors
Color Gamut	81 %**

* Based on estimation

** ST2420L/ST2421L Color Gamut (Typical) is based on CIE1976 (81 %) and CIE1931 (68 %).

Resolution

Model	ST2420L/ST2421L
Horizontal scan range	30 kHz to 83 kHz (automatic)
Vertical scan range	56 Hz to 76 Hz (automatic)
Maximum preset resolution	1920 x 1080 at 60 Hz

Video Supported Modes

Model	ST2420L/ST2421L
Video display capabilities (HDMI playback)	480i/480p/576i/576p/720p/1080i/1080p

Preset Display Modes

ST2420L/ST2421L

Display Mode	Horizontal Frequency (kHz)	Vertical Frequency (Hz)	Pixel Clock (MHz)	Sync Polarity (Horizontal/Vertical)
VGA, 720 x 400	31.469	70.087	28.3	-/+
VGA, 640 x 480	31.469	59.940	25.2	-/-
VGA, 640 x 480	37.500	75.000	31.5	-/-
VESA, 800 x 600	37.879	60.317	40.0	+/+
VESA, 800 x 600	46.875	75.000	49.5	+/+
VESA, 1024 x 768	48.363	60.004	65.0	-/-
VESA, 1024 x 768	60.023	75.029	78.8	+/+
VESA, 1152 x 864	67.500	75.000	108.0	+/+
VESA, 1280 x 1024	64.000	60.000	108.0	+/+
VESA, 1280 x 1024	79.976	75.025	135.0	+/+
VESA, 1920 x 1080	67.500	60.000	148.5	+/+

Electrical

Model	ST2420L/ST2421L
Video input signals	Analog RGB, 0.7 Volts +/- 5%, positive polarity at 75 ohm input impedance Digital DVI-D TMDS, 600mV for each differential line, positive polarity at 50 ohm input impedance HDMI, 600mV for each differential line, 100 ohm input impedance per differential pair
Synchronization input signals	Separate horizontal and vertical synchronizations, polarity-free TTL level, SOG (Composite SYNC on green)
AC input voltage/frequency/current	100 to 240 VAC/50 or 60 Hz \pm 3 Hz/2.0A (Max.)
Inrush iso surge current	120 V: 30 A (Max.) 240 V: 60 A (Max.)

Physical Characteristics

Model	ST2420L/ST2421L
Connector type	<ul style="list-style-type: none"> D-sub: Blue connector DVI-D: White connector HDMI
Signal cable type	<ul style="list-style-type: none"> D-sub: Detachable, Analog, 15 pin, shipped attached to the monitor DVI-D HDMI

Dimensions (with stand)	
Height	418.24 mm (16.47 inches)
Width	574.96 mm (22.64 inches)
Depth	203.68 mm (8.02 inches)
Dimensions (without stand)	
Height	356.43 mm (14.03 inches)
Width	574.96 mm (22.64 inches)
Depth	59.72 mm (2.35 inches)
Stand dimensions	
Height	149.85 mm (5.90 inches)
Width	203.68 mm (8.02 inches)
Depth	203.68 mm (8.02 inches)
Weight	
Weight with packaging	5.75 kg (12.68 lb)
Weight with stand assembly and cables	4.29 kg (9.46 lb)
Weight without stand assembly (for wall mount or VESA mount considerations - no cables)	3.65 kg (8.05 lb)
Weight of stand assembly	0.64 kg (1.41 lb)

Environmental

Model	ST2420L/ST2421L
Temperature	
Operating	0° to 40° C (32° to 104°F)
Non-operating	Storage: -20° to 60° C (-4° to 140° F) Shipping: -20° to 60° C (-4° to 140° F)
Humidity	
Operating	10% to 80% (non-condensing)
Non-operating	Storage: 5% to 90% (non-condensing) Shipping: 5% to 90% (non-condensing)
Altitude	
Operating	4,485 m (14,700 ft) max
Non-operating	12,191 m (40,000 ft) max
Thermal dissipation	102.36 BTU/hour (maximum) 68.24 BTU/hour (typical)

Plug and Play Capability

You can install the monitor in any Plug and Play-compatible system. The monitor automatically provides the computer system with its Extended Display Identification Data (EDID) using Display Data Channel (DDC) protocols so that the system can configure itself and optimize the monitor settings. If required, the user can select different settings, but in most cases monitor installation is automatic.

LCD Monitor Quality & Pixel Policy

During the LCD Monitor manufacturing process, it is not uncommon for one or more pixels to become fixed in an unchanging state. The visible result is a fixed pixel that appears as an extremely tiny dark or bright discolored spot. When the pixel remains permanently lit, it is known as a "bright dot." When the pixel remains black, it is known as a "dark dot."

In almost every case, these fixed pixels are hard to see and do not detract from display quality or usability. A display with 1 to 5 fixed pixels is considered normal and within competitive standards. For more information, see Dell Support site at: support.dell.com.

Maintenance Guidelines

Caring for Your Monitor

 **CAUTION:** Read and follow the [Safety Instructions](#) before cleaning the monitor.

 **CAUTION:** Before cleaning the monitor, unplug the monitor from the electrical outlet.

For best practices, follow the instructions in the list below while unpacking, cleaning, or handling your monitor:

- 1 To clean your antistatic screen, lightly dampen a soft, clean cloth with water. If possible, use a special screen-cleaning tissue or solution suitable for the antistatic coating. Do not use benzene, thinner, ammonia, abrasive cleaners, or compressed air.
- 1 Use a **lightly-dampened, warm cloth to clean the monitor. Avoid using detergent of any kind as some detergents leave a milky film on the monitor.**
- 1 If you notice a white powder when you unpack your monitor, wipe it off with a cloth.
- 1 Handle your monitor with care as dark-colored monitors may scratch and show white scuff marks more than lighter-colored monitors.
- 1 To help maintain the best image quality on your monitor, use a dynamically changing screen saver and turn off your monitor when not in use.

[Back to Contents Page](#)

[Back to Contents Page](#)

Appendix

Dell™ ST2420L/ST2421L monitor User's Guide

- [Safety Instructions](#)
 - [FCC Notice \(U.S. Only\) and Other Regulatory Information](#)
 - [Contacting Dell](#)
-

CAUTION: Safety Instructions

 **CAUTION:** Use of controls, adjustments, or procedures other than those specified in this documentation may result in exposure to shock, electrical hazards, and/or mechanical hazards.

For information on safety instructions, see the *Safety Information* that ships with your monitor.

FCC Notice (U.S. Only) and Other Regulatory Information

For FCC notices and other regulatory information, see the regulatory compliance website located at www.dell.com/regulatory_compliance.

Contacting Dell

For customers in the United States, call 800-WWW-DELL (800-999-3355).

 **NOTE:** If you do not have an active Internet connection, you can find contact information on your purchase invoice, packing slip, bill, or Dell product catalog.

Dell provides several online and telephone-based support and service options. Availability varies by country and product, and some services may not be available in your area. To contact Dell for sales, technical support, or customer service issues:

1. Visit support.dell.com.
 2. Verify your country or region in the **Choose A Country/Region** drop-down menu at the bottom of the page.
 3. Click **Contact Us** on the left side of the page.
 4. Select the appropriate service or support link based on your need.
 5. Choose the method of contacting Dell that is convenient for you.
-

[Back to Contents Page](#)

[Back to Contents Page](#)

Setting Up Your Monitor

Dell™ ST2420L/ST2421L monitor

If you have a Dell™ desktop or a Dell™ portable computer with internet access

1. Go to <http://support.dell.com>, enter your service tag, and download the latest driver for your graphics card.
2. After installing the drivers for your Graphics Adapter, attempt to set the resolution to **1920x1080** again.

 **NOTE:** If you are unable to set the resolution to 1920x1080, please contact Dell™ to inquire about a Graphics Adapter that supports these resolutions.

[Back to Contents Page](#)

[Back to Contents Page](#)

Setting Up Your Monitor

Dell™ ST2420L/ST2421L monitor

If you have a non Dell™ desktop, portable computer, or graphics card

In Windows XP:

1. Right-click on the desktop and click **Properties**.
2. Select the **Settings** tab.
3. Select **Advanced**.
4. Identify your graphics controller supplier from the description at the top of the window (e.g. NVIDIA, ATI, Intel etc.).
5. Please refer to the graphics card provider website for updated driver (for example, <http://www.ATI.com> OR <http://www.NVIDIA.com>).
6. After installing the drivers for your Graphics Adapter, attempt to set the resolution to **1920x1080** again.

In Windows Vista® or Windows 7:

1. Right-click on the desktop and click **Personalization**.
2. Click **Change Display Settings**.
3. Click **Advanced Settings**.
4. Identify your graphics controller supplier from the description at the top of the window (e.g. NVIDIA, ATI, Intel etc.).
5. Please refer to the graphics card provider website for updated driver (for example, <http://www.ATI.com> OR <http://www.NVIDIA.com>).
6. After installing the drivers for your Graphics Adapter, attempt to set the resolution to **1920x1080** again.

 **NOTE:** If you are unable to set the resolution to 1920x1080 , please contact the manufacturer of your computer or consider purchasing a graphics adapter that will support the video resolution of 1920x1080 .

[Back to Contents Page](#)

Operating the Monitor





Dell™ ST2420L/ST2421L monitor User's Guide

- [Using the Front Panel Controls](#)
- [Using the On-Screen Display \(OSD\) Menu](#)
- [Setting the Maximum Resolution](#)
- [Using the Dell Soundbar \(Optional\)](#)
- [Using the Tilt](#)

Using the Front Panel

Use the control buttons on the side of the monitor to adjust the characteristics of the image being displayed. As you use these buttons to adjust the controls, an OSD shows the numeric values of the characteristics as they change.



1-2	Shortcut keys	Use this button for direct access to the control menu that you define in the personalize menu. *The default settings are Preset Modes Select and Brightness/Contrast Select.
1	 Preset Modes Select	Use this button for different display preset modes on your monitor.
2	 Brightness/Contrast	Use this button to access the "Brightness/Contrast" control menu.
3	 OSD Menu	Use this button to open the On-Screen Display (OSD). See Using the OSD Menu .
4	 Exit	Use this button to exit the OSD menu.
5	 Power button	Use the power button to turn the monitor on and off. The white light indicates that the monitor is on and fully functional. An amber light indicates power save mode.

Using the On-Screen Display (OSD) Menu

 **NOTE:** If you change the settings and then either proceed to another menu, or exit the OSD menu, the monitor automatically saves the changes. The changes are also saved if you change the settings and then wait for the OSD menu to disappear.

1. Press any key to launch the OSD menu and press  to display the main menu.

Main Menu for Analog (VGA) Input

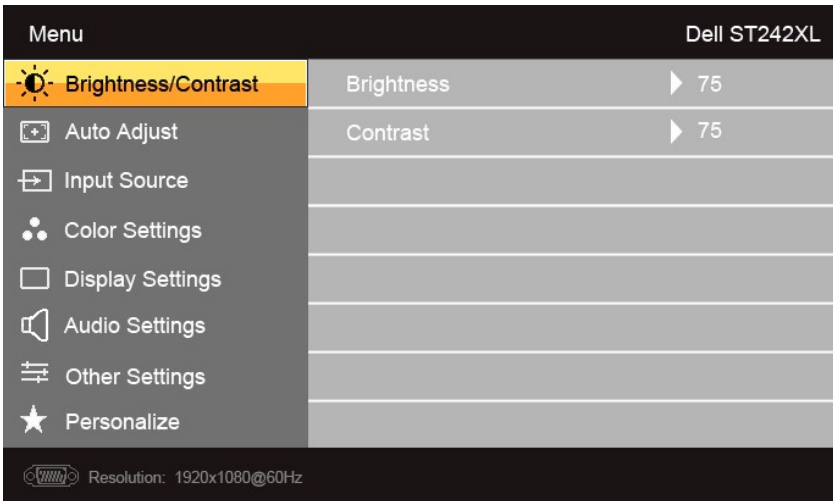

Or

Main Menu for non Analog (non VGA) Input

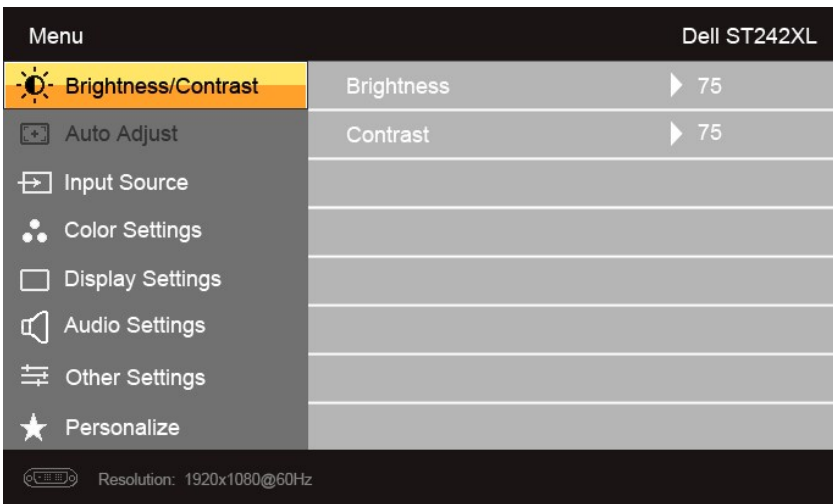

NOTE: Auto Adjust is only available when you are using the analog (VGA) connector.

2. Press the **▼** and **▲** buttons to move between the setting options. As you move from one icon to another, the option name is highlighted. See the table for a complete list of all the options available for the monitor.
3. Press the **→** button once to activate the highlighted option.
4. Press the **▼** and **▲** buttons to select the desired parameter.
5. Press the **→** button to enter the slide bar and then use the **▼** and **▲** buttons, according to the indicators on the menu, to make your changes.
6. Press the **↶** button to return to the main menu or exit the OSD menu.

Icon	Menu and Submenus	Description
	Brightness/Contrast	Allows you to adjust the brightness and contrast.

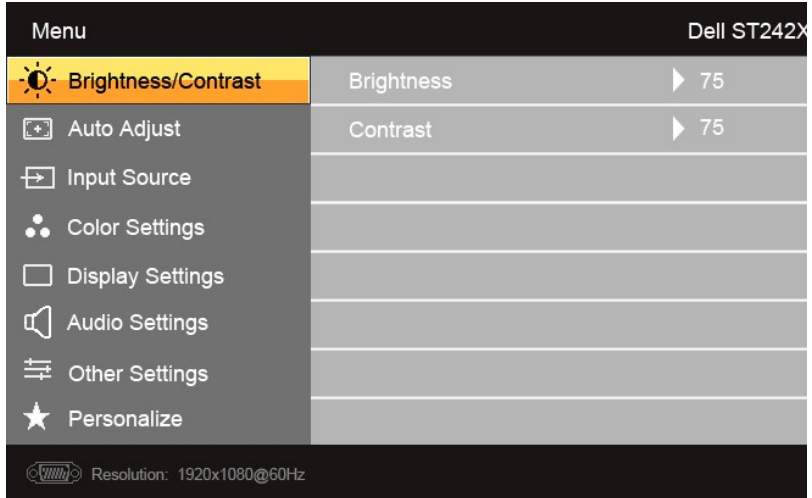

Brightness Brightness adjusts the luminance of the backlight.
Press the **▲** button to increase the brightness and Press the **▼** button to decrease the brightness (min 0 ~ max 100)

Contrast Adjust the Brightness first, and then adjust the Contrast only if further adjustment is necessary.
Press the **▲** button to increase contrast and press the **▼** button to decrease contrast (min 0 ~ max 100)
The Contrast function adjusts the degree of difference between the darkest and lightest areas on the monitor.

Back Press the **↶** button to go back to or exit the main menu.

 **Auto Adjust**

Even though your computer recognizes your monitor on startup, the Auto Adjustment function optimizes the image.

NOTE: In most cases, Auto Adjust produces the best image for your configuration.

 **Input Source**

The Input Source menu is used to select between different video signals that may be connected to your computer.

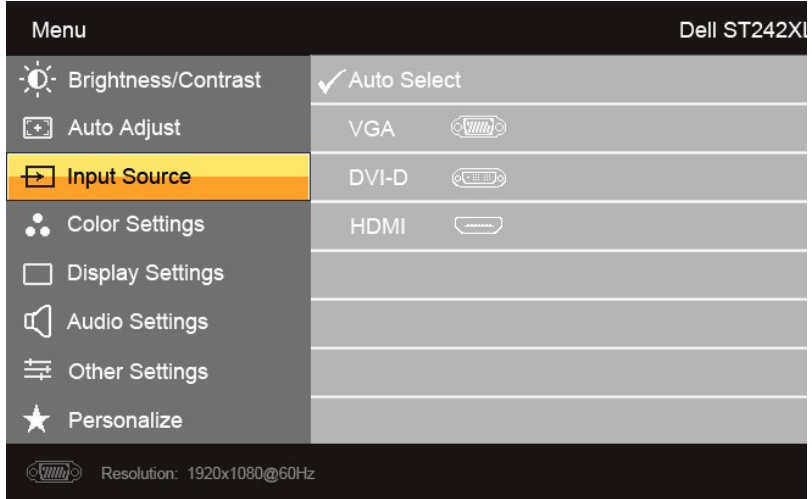

Auto Select Scan for Sources. Push **✓** to scan for available input signals.

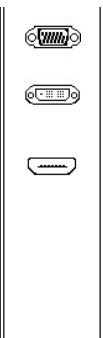

- VGA** Select VGA input when you are using the analog (VGA) connector. Push to select the VGA input source.
- DVI-D** Select DVI-D input when you are using the Digital (DVI) connector. Push to select the DVI input source.
- HDMI** Select HDMI input when you are using the HDMI connector. Push to select the HDMI input source.
- Back** Push the  button to go back to or exit the main menu.



Color Settings

VGA input

Video input

Use the color settings to adjust the Image mode and color format.

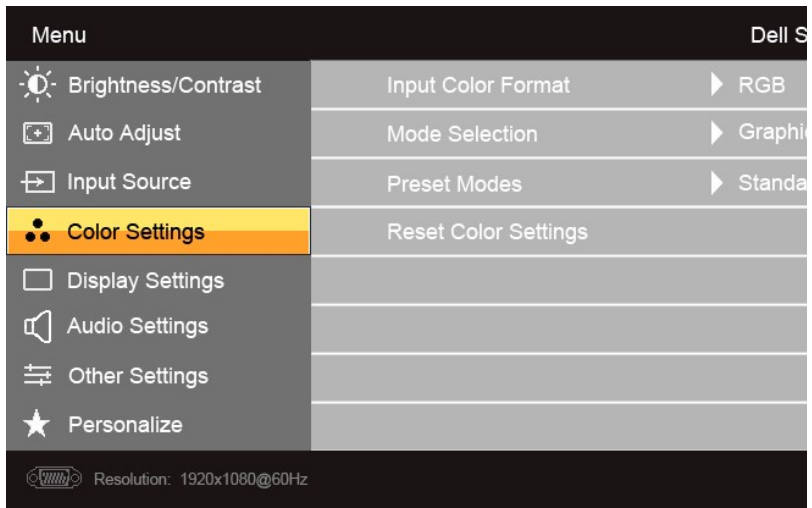

- Input Color Format** Allows you to set the color format.
- Mode Selection** Allows you to set the display mode to Graphics or Video. If your computer is connected to your monitor, c
- Preset Modes**
- Standard** Mode suitable for desktop applications.
- Multimedia** Mode for multimedia applications, e.g., video playback.
- Game** Mode suitable for gaming applications.
- Warm** Select warm mode to obtain a red tint. This color setting is typically used for color-intensive applications i
- Cool** Select cool mode to obtain a bluish tint. This color setting is typically used for text based applications (sp
- Custom (RGB)** Use the or buttons to increase or decrease each of the three colors (R, G, B) independently, in sir

Movie Mode suitable for movie playback.

Game Mode suitable for game applications.

Sports Mode suitable for sports scenes.

Nature Mode suitable for nature scenes.

Hue This feature can make the video image color shift from green to purple. Use this feature to adjust the sk

▼ increases the green hue in the image

▲ increases the purple hue in the image

NOTE: Hue adjustment is only available for video input.

Saturation Allows you to adjust the color saturation of the video image. Use ▼ or ▲ buttons to adjust the saturati

▼ makes video image looks monochrome

▲ makes video image looks colorful

NOTE: Saturation adjustment is only available for video input.

Demo Mode Vertically splits the screen into two segments. The left half of the screen in the normal mode and the rig

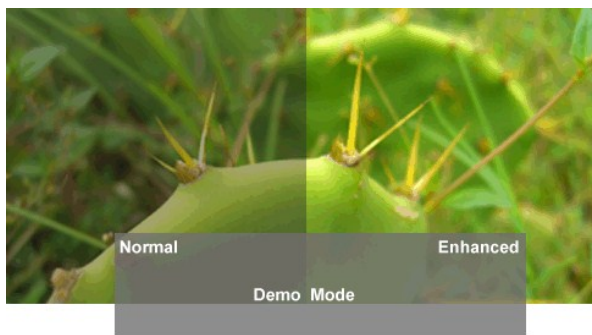

NOTE: Demo Mode is only available for video input.

Reset Color Settings Returns your monitor color settings to the factory default settings.

Back Press the  button to go back to or exit the main menu.



Display Settings

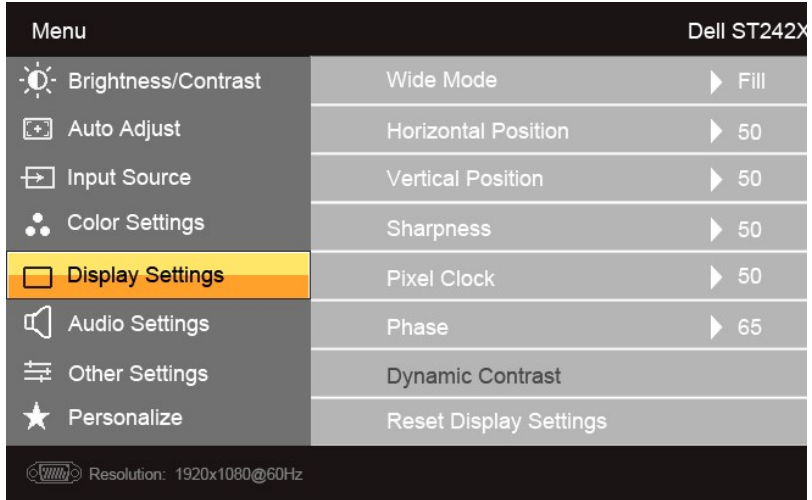

Wide Mode

Adjusts the image ratio as 4:3 or full screen.

Horizontal Position

NOTE: Wide Mode adjustment is not required at maximum preset resolution 1920 x 1080. Use the and buttons to adjust image left and right. Minimum is '0' (-). Maximum is '100' (+).

Vertical Position

Use the and buttons to adjust image up and down. Minimum is '0' (-). Maximum is '100' (+).

Sharpness

This feature can make the image look sharper or softer. Use or to adjust the sharpness from '0' to

Pixel Clock

The Phase and Pixel Clock adjustments allow you to adjust your monitor to your preference. These settings Use the and buttons to adjust for best image quality.

Phase

If satisfactory results are not obtained using the Phase adjustment, use the Pixel Clock (coarse) adjustment

Dynamic Contrast

Allows you to increase the level of contrast to provide sharper and more detailed image quality.

Reset Display Setting

Resets the display settings to the factory default settings.

Back



Press the button to go back to or exit the main menu.

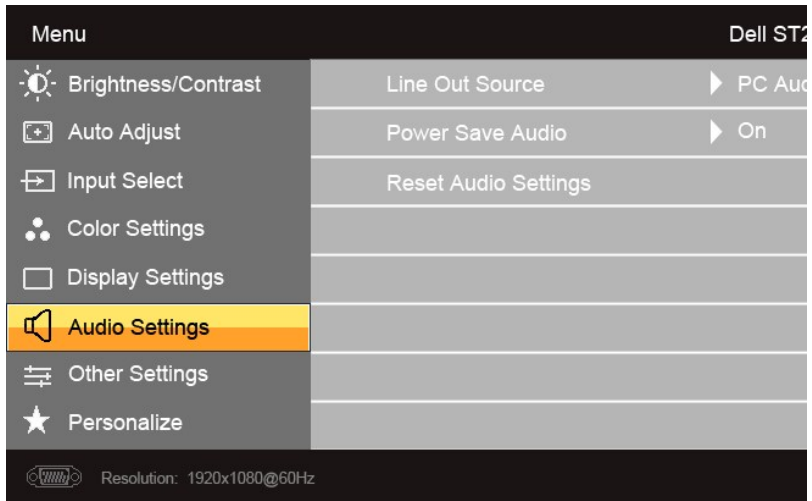

Audio Settings

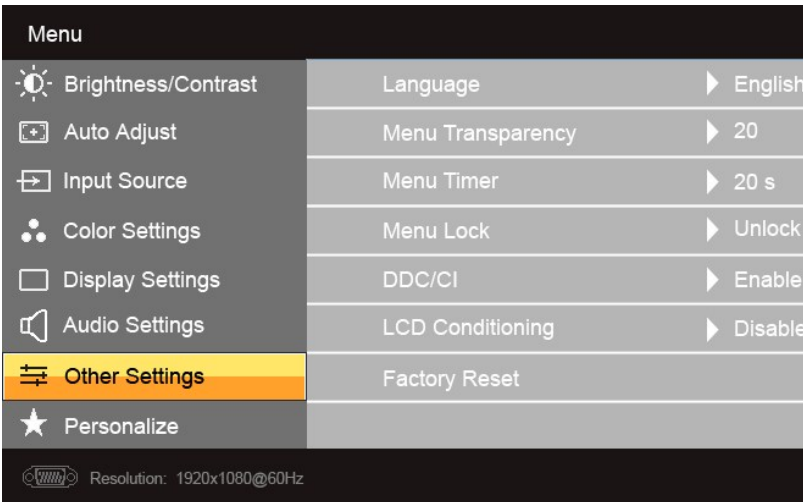

	<p>Line Out Source Select the source of the audio</p> <p>Power Save Audio Turns the Audio Power on or off during power save mode.</p> <p>Reset Audio Settings Resets the audio settings to the original factory settings.</p> <p>Back Push  to go back to or exit the main menu.</p>
--	---

	<p>Other Settings</p>	
	<p>Language Language option to set the OSD display to one of 6 languages (English, Espanol, Francais, Deutsch, Sim</p>	
	<p>Menu Transparency Allows you to adjust the OSD background from opaque to transparent.</p>	
	<p>Menu Timer OSD Hold Time: Sets the amount of time the OSD will remain active after the last time you pressed a but Use the  and  buttons to adjust the slider in 5 second increments, from 5 to 60 seconds.</p>	
	<p>Menu Lock Controls user access to adjustments. When selected, no user adjustments are allowed. All buttons are l NOTE: Lock function – Either soft lock (through OSD menu) or hard lock (Press and hold the button abo Unlock function– Only hard unlock (Press and hold the button above power button for 10 sec)</p>	
	<p>DDC/CI DDC/CI (Display Data Channel/Command Interface) allows your monitor parameters (brightness, color b Enable this feature for best user experience and optimum performance of your monitor.</p>	



LCD Conditioning

If an image appears to be retained on the monitor, select **LCD Conditioning** to help eliminate any image does not remove burn-in.

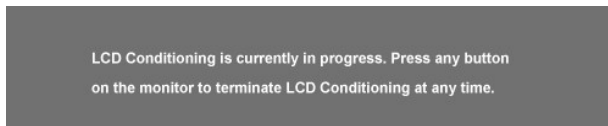
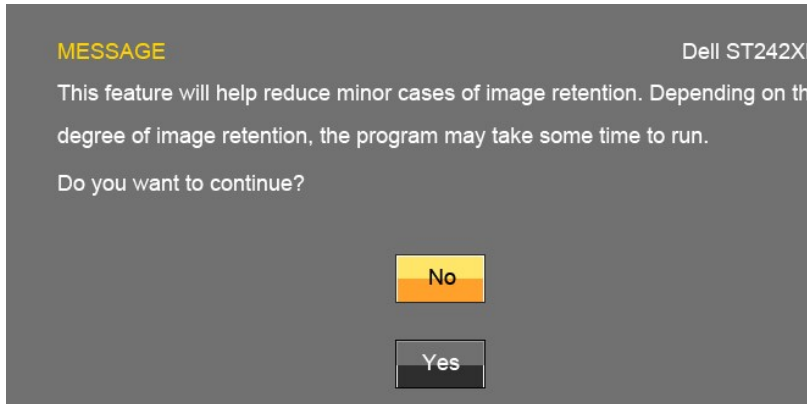

Factory Reset

Reset all OSD settings to the factory default settings.

Back

Press the  button to go back to or exit the main menu.



Personalize

There are 2 shortcut keys on the front panel. Select one control menu for each shortcut key to allow dire

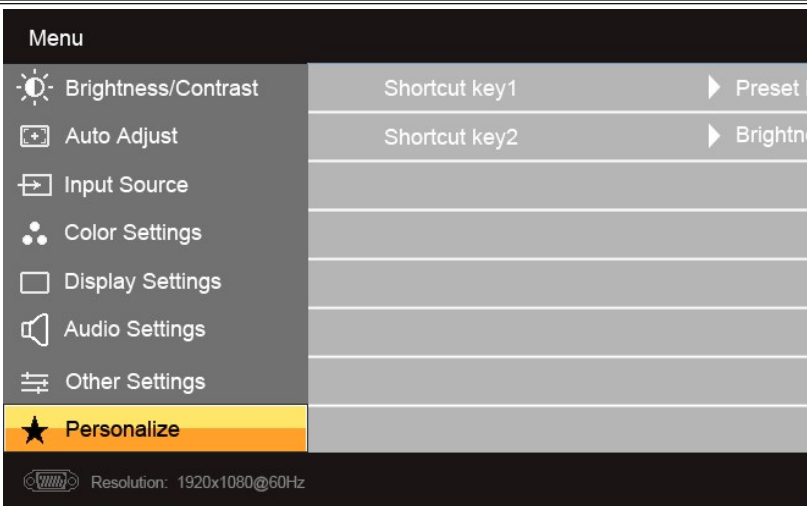

OSD Warning Messages

When the monitor does not support a particular resolution mode you will see the following message :

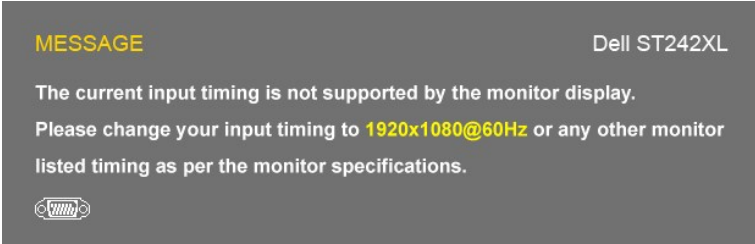

or



This means that the monitor cannot synchronize with the signal that it is receiving from the computer. See [Monitor Specifications](#) for the Horizontal and Vertical frequency of the monitor. The recommended mode is 1920x1080.

When monitor enters Power Save mode, the following message appears :

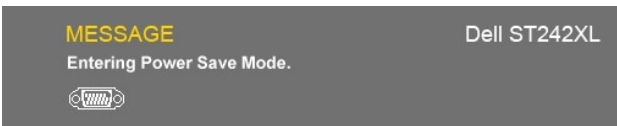

or

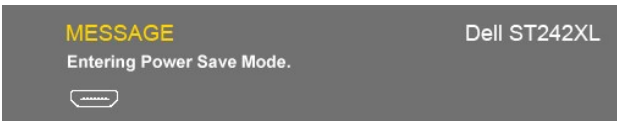
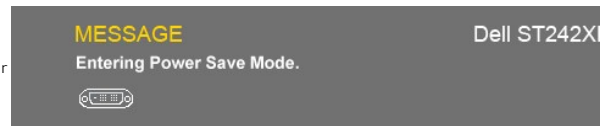

Activate the computer and wake up the monitor to gain access to the [OSD](#)

If you press any button other than the power button the following message will appear:

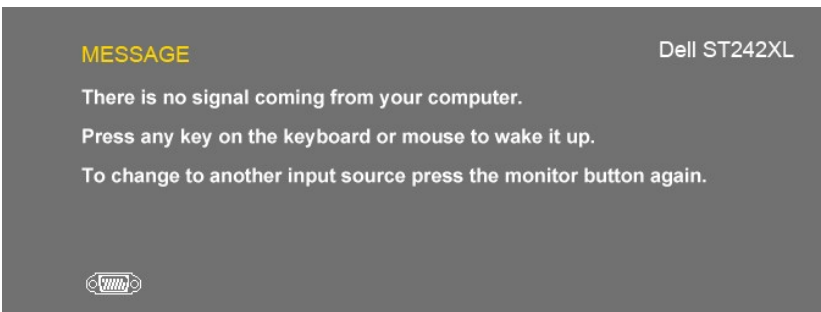

or

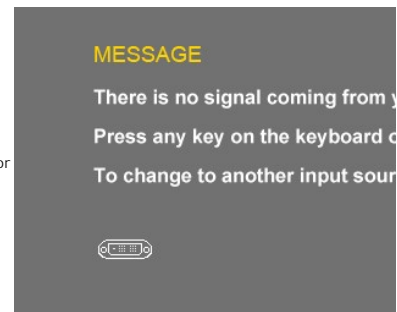

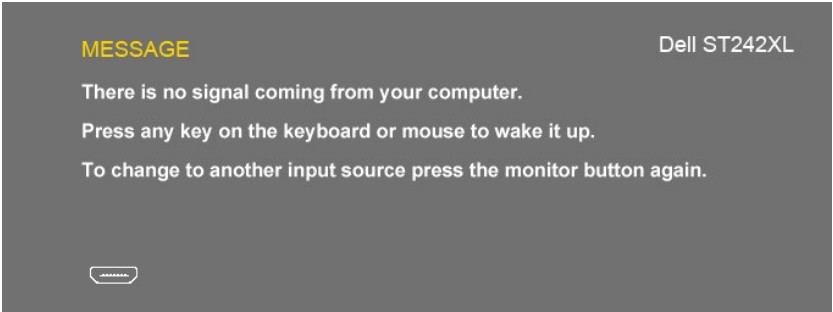

If VGA/DVI/HDMI input is selected and both VGA, DVI and HDMI cable are not connected, a floating dialog box as shown below appears. The monitor will enter **Power Save Mode after 15 minutes** if left at this state.



See [Solving Problems](#) for more information.

Setting the Maximum Resolution

To set the maximum resolution for the monitor.

Windows XP:

1. Right-click on the desktop and select **Properties**.
2. Select the **Settings** tab.
3. Set the screen resolution to 1920 x 1080.
4. Click **OK**.

Windows Vista® or Windows® 7:

1. Right-click on the desktop and select **Personalization**.
2. Click **Change Display Settings**.
3. Move the slider-bar to the right by pressing and holding left-mouse button and adjust the screen resolution to **1920 x 1080**.
4. Click **OK**.

If you do not see 1920 x 1080 as an option, you may need to update your graphics driver. Depending on your computer, complete one of the following procedures.

If you have a Dell desktop or portable computer:

- o Go to support.dell.com, enter your service tag, and download the latest driver for your graphics card.

If you are using a non-Dell computer (portable or desktop):

- o Go to the support site for your computer and download the latest graphic drivers.
- o Go to your graphics card website and download the latest graphic drivers.

Using the Dell Soundbar (Optional)

The Dell Soundbar is a stereo two channel system mountable on Dell flat panel displays. The Soundbar has a capacitive touch front control panel, a white LED for power indication, and two audio headset jacks.

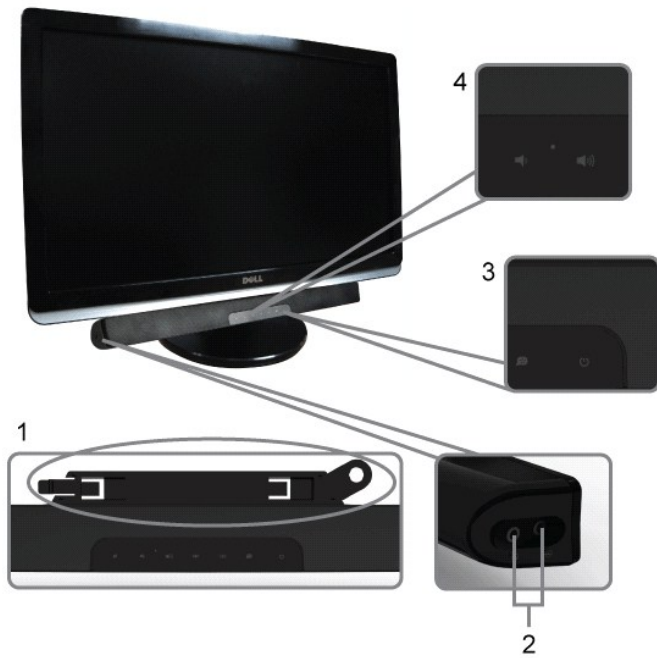

1. Attach mechanism
 2. Headphone connectors
 3. Power indicator
 4. Power/Volume control
-

Using the Tilt

Tilt

With the built-in pedestal, you can tilt the monitor for the most comfortable viewing angle.



 **NOTE:** The stand riser and stand base are detached when the monitor is shipped from the factory.

[Back to Contents Page](#)

Setting Up Your Monitor

Dell™ ST2420L/ST2421L monitor

Important instructions to set the display resolution to 1920x1080 (Maximum)

For optimal display performance while using the Microsoft Windows® operating systems, set the display resolution to 1920 x 1080 pixels by performing the following steps:

In Windows XP:

1. Right-click on the desktop and click **Properties**.
2. Select the **Settings** tab.
3. Move the slider-bar to the right by pressing and holding the left-mouse button and adjust the screen resolution to **1920x1080**.
4. Click **OK**.

In Windows Vista® or Windows® 7:

1. Right-click on the desktop and click **Personalization**.
2. Click **Change Display Settings**.
3. Move the slider-bar to the right by pressing and holding the left-mouse button and adjust the screen resolution to **1920x1080**.
4. Click **OK**.

If you do not see **1920x1080** as an option, you may need to update your graphics driver. Please choose the scenario below that best describes the computer system you are using, and follow the provided directions:

1: [If you have a Dell™ desktop or a Dell™ portable computer with internet access.](#)

2: [If you have a non Dell™ desktop, portable computer, or graphics card.](#)

Dell™ ST2420L/ST2421L monitor

- [User Guide](#)
- [Important instructions to set the display resolution to 1920x1080 \(Maximum\)](#)

Information in this document is subject to change without notice.
© 2010 Dell™ Inc. All rights reserved.

Reproduction of these materials in any manner whatsoever without the written permission of Dell Inc. is strictly forbidden.

Trademarks used in this text: *Dell* and the *DELL* logo, are trademarks of Dell Inc. *Microsoft* and *Windows* are either registered trademarks or trademarks of Microsoft Corporation in the United States and/or other countries. *ENERGY STAR* is a registered trademark of the U.S. Environmental Protection Agency. As an ENERGY STAR partner, Dell Inc. has determined that this product meets the ENERGY STAR guidelines for energy efficiency.

Other trademarks and trade names may be used in this document to refer to either the entities claiming the marks and names or their products. Dell Inc. disclaims any proprietary interest in trademarks and trade names other than its own.

ST2420Lb/ST2421Lb

June 2010 Rev. A00

Setting Up the Monitor

Dell™ ST2420L/ST2421L monitor User's Guide

- [Attaching the Base](#)
- [Connecting the Monitor](#)
- [Attaching the Soundbar \(Optional\)](#)
- [Removing the Monitor Stand](#)

Attaching the Base

 **NOTE:** The stand riser and stand base are detached when the monitor is shipped from the factory.

1. Assemble the stand riser to stand base.
 - a. Place the stand riser on top of the stand base. Slide the stand riser horizontally until the tabs are fully inserted into the stand base grooves.

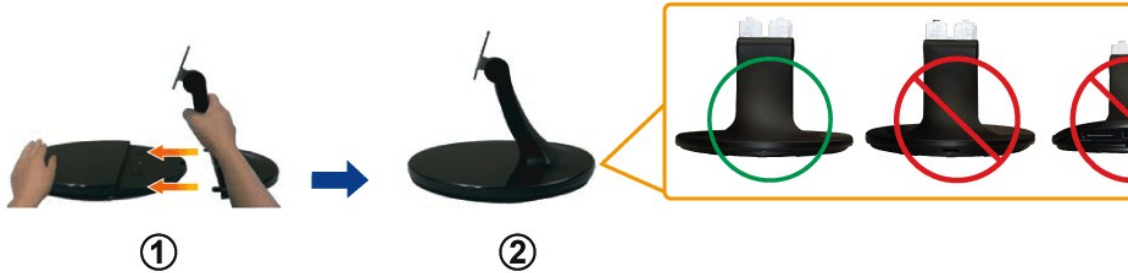

- b. Tighten the thumbscrew below the stand base.



2. Attach the stand assembly to the monitor.
 - a. Place the monitor on a soft cloth or cushion near the edge of desk.



- b. Align the stand assembly bracket to the monitor groove.
- c. Insert the bracket towards monitor until it locked in place.

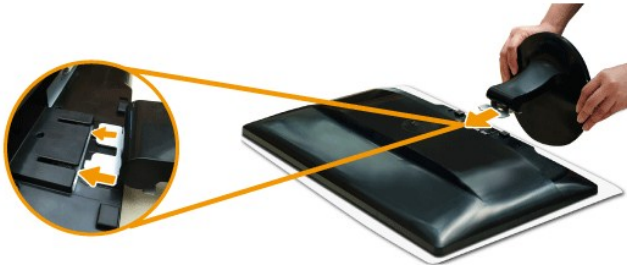

Connecting the Monitor

⚠ CAUTION: Before you begin any of the procedures in this section, follow the [safety instructions](#).

To connect your monitor to the computer perform the following steps/instructions:

1. Turn off your computer and disconnect the power cable.
2. Connect the HDMI cable, white (digital DVI-D), or blue (analog VGA) display connector cable to the corresponding video port on the back of your computer. Do not use all the cables on the same computer. Use all of the cables only when they are connected to different computers with appropriate video systems.

Connecting the blue VGA cable



Connecting the White DVI Cable*



Connecting the HDMI Cable*



📌 NOTE: *Optional purchase item. To purchase DVI or HDMI cable, please visit [Dell.com](#)

📌 NOTE: The Graphics are used for the purpose of illustration only. Appearance of the the computer may vary.

After you have completed connecting the VGA/DVI/HDMI cable, follow the procedure below to complete your monitor setup:

1. Plug the power cables for your computer and monitor into a nearby outlet.

2. Turn on the monitor and the computer.
If your monitor displays an image, installation is complete. If it does not display an image, see [Solving Problems](#).
-

Attaching the Soundbar (Optional)



1. Working from the rear of the monitor, attach the Soundbar by aligning the two slots with the two tabs along the bottom rear of the monitor.
2. Slide the Soundbar to the left until it snaps into place.
3. Connect the Soundbar with the DC power connector.
4. Insert the mini stereo plug from the rear of the Soundbar into the computer's audio output jack or the monitor's audio output jack.

🔊 **NOTICE:** Do not use with any device other than the Dell Soundbar.

Removing the Monitor Stand



After placing the monitor panel on a soft cloth or cushion, complete the following steps to remove the base.

1. Use a long screwdriver to push the release latch located in a hole just above the stand.
 2. Once the latch is released, remove the base away from the monitor.
-

[Back to Contents Page](#)

[Back to Contents Page](#)

Solving Problems

Dell™ ST2420L/ST2421L monitor User's Guide

- [Self-Test](#)
- [Built-in Diagnostics](#)
- [Common Problems](#)
- [Product-Specific Problems](#)
- [Troubleshooting the Dell™ Soundbar \(Optional\)](#)

 **CAUTION:** Before you begin any of the procedures in this section, follow the [Safety Instructions](#).

Self-Test

Your monitor provides a self-test feature that allows you to check whether your monitor is functioning properly. If your monitor and computer are properly connected but the monitor screen remains dark, run the monitor self-test by performing the following steps:

1. Turn off both your computer and the monitor.
2. Unplug the video cable from the back of the computer. To ensure proper Self-Test operation, remove the Analog (blue connector) cable from the back of computer.
3. Turn on the monitor.

The floating dialog box should appear on-screen (against a black background) if the monitor cannot sense a video signal and is working correctly. While in self-test mode, the power LED remains white. Also, the dialog shown below will continuously scroll through the screen.



4. This box also appears during normal system operation, if the video cable becomes disconnected or damaged. The monitor will enter **Power Save Mode after 15 minutes** if left at this state.
5. Turn off your monitor and reconnect the video cable; then turn on both your computer and the monitor.

If your monitor screen remains blank after you have performed Step 5, check your video controller and computer system.

Built-in Diagnostics

Your monitor has a built-in diagnostic tool that helps you determine if the screen abnormality you are experiencing is an inherent problem with your monitor, or with your computer and video card.

 **NOTE:** You can run the built-in diagnostics only when the video cable is unplugged and the monitor is in *self-test mode*.

To run the built-in diagnostics:

1. Ensure that the screen is clean (no dust particles on the surface of the screen).
2. Unplug the video cable(s) from the back of the computer or monitor. The monitor then goes into the self-test mode.
3. On the front panel, press and hold the **shortcut button 1** and **shortcut button 4** keys on the front panel, simultaneously for 2 seconds. A gray screen appears.

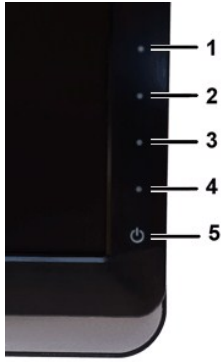

4. Carefully inspect the screen for abnormalities.
5. Press the **shortcut button 4** key on the front panel again. The color of the screen changes to red.
6. Inspect the display for any abnormalities.
7. Repeat steps 5 and 6 to inspect the display in green, blue, and white colored screens.

The test is complete when the white screen appears. To exit, press the **shortcut button 4** again.

If you do not detect any screen abnormalities upon using the built-in diagnostic tool, the monitor is functioning properly. Check the video card and computer.

OSD Warning Messages

For OSD-related issues, see [OSD Warning Messages](#).

Common Problems

The following table contains general information about common monitor problems that you might encounter and the possible solutions.

Common Symptoms	What You Experience	Possible Solutions
No Video/Power LED off	No picture	<ul style="list-style-type: none"> 1 Ensure that the video cable connecting the monitor and the computer is properly connected. 1 Verify that the power outlet is functioning properly using any other electrical equipment. 1 Ensure that the power button is depressed fully.
No Video/Power LED on	No picture or no brightness	<ul style="list-style-type: none"> 1 Increase brightness & contrast controls via OSD. 1 Perform monitor self-test feature check. 1 Check for bent or broken pins in the video cable connector. 1 Run the built-in diagnostics.
Poor Focus	Picture is fuzzy, blurry, or ghosting	<ul style="list-style-type: none"> 1 Perform Auto Adjust via OSD. 1 Adjust the Phase and Pixel Clock controls via OSD. 1 Eliminate video extension cables. 1 Reset the monitor to Factory Settings. 1 Change the video resolution to the correct aspect ratio (16:9).
Shaky/Jittery Video	Wavy picture or fine movement	<ul style="list-style-type: none"> 1 Perform Auto Adjust via OSD. 1 Adjust the Phase and Pixel Clock controls via OSD. 1 Reset the monitor to Factory Settings. 1 Check environmental factors. 1 Relocate the monitor and test in another room.
Missing Pixels	LCD screen has spots	<ul style="list-style-type: none"> 1 Cycle power on-off. 1 Pixel that is permanently off is a natural defect that can occur in LCD technology. 1 Run the built-in diagnostics.
Stuck-on Pixels	LCD screen has bright spots	<ul style="list-style-type: none"> 1 Cycle power on-off. 1 Pixel that is permanently off is a natural defect that can occur in LCD technology. 1 Run the built-in diagnostics.
Brightness Problems	Picture too dim or too bright	<ul style="list-style-type: none"> 1 Reset the monitor to Factory Settings. 1 Auto Adjust via OSD. 1 Adjust brightness & contrast controls via OSD.
Geometric Distortion	Screen not centered correctly	<ul style="list-style-type: none"> 1 Reset the monitor to Factory Settings. 1 Auto Adjust via OSD. 1 Adjust brightness & contrast controls via OSD.
Horizontal/Vertical Lines	Screen has one or more lines	<ul style="list-style-type: none"> 1 Reset the monitor to Factory Settings. 1 Perform Auto Adjust via OSD.

		<ul style="list-style-type: none"> 1 Adjust Phase and Pixel Clock controls via OSD. 1 Perform monitor self-test feature check and determine if these lines are also in self- 1 Check for bent or broken pins in the video cable connector. 1 Run the built-in diagnostics.
Synchronization Problems	Screen is scrambled or appears torn	<ul style="list-style-type: none"> 1 Reset the monitor to Factory Settings. 1 Perform Auto Adjust via OSD. 1 Adjust Phase and Pixel Clock controls via OSD. 1 Perform monitor self-test feature check to determine if scrambled screen appears in mode. 1 Check for bent or broken pins in the video cable connector. 1 Restart the computer in the <i>safe mode</i>.
Safety Related Issues	Visible signs of smoke or sparks	<ul style="list-style-type: none"> 1 Do not perform any troubleshooting steps. 1 Contact Dell immediately.
Intermittent Problems	Monitor turns on & off	<ul style="list-style-type: none"> 1 Ensure that the video cable connecting the monitor to the computer is connected properly. 1 Reset the monitor to Factory Settings. 1 Perform monitor self-test feature check to determine if the intermittent problem occurs in mode.
Missing Color	Picture lacks color	<ul style="list-style-type: none"> 1 Perform monitor self-test feature check. 1 Ensure that the video cable connecting the monitor to the computer is connected properly. 1 Check for bent or broken pins in the video cable connector.
Wrong Color	Picture color is not good	<ul style="list-style-type: none"> 1 Change the Color Setting Mode in the Color Settings OSD to Graphics or Video depending on application. 1 Try a different Color Preset Setting in Color Settings OSD. Adjust R/G/B value in Color OSD if the Color Management is turned off. 1 Change the Input Color Format to PC RGB or YPbPr in the Advance Setting OSD.
Image retention from a static image left on the monitor for a long period of time	Faint shadow from the static image displayed appears on the screen	<ul style="list-style-type: none"> 1 Use the Power Management feature to turn off the monitor at all times when not in use. For more information, see Power Management Modes. 1 Alternatively, use a dynamically changing screensaver.

Product-Specific Problems

SPECIFIC SYMPTOMS	WHAT YOU EXPERIENCE	POSSIBLE SOLUTIONS
Screen image is too small	Image is centered on screen, but does not fill entire viewing area	<ul style="list-style-type: none"> 1 Perform monitor reset on "Factory Reset"
Cannot adjust the monitor with the buttons on the front panel	OSD does not appear on the screen	<ul style="list-style-type: none"> 1 Turn the monitor off and unplug the power cord and then plug back and power on
No Input Signal when user controls pressed	No picture, the LED light is amber. When control button is pressed, the message " No VGA cable", "No DVI-D cable" or "No HDMI cable" will appear.	<ul style="list-style-type: none"> 1 Check the signal source. Ensure that the computer is not in power saving by moving the mouse or pressing any key on the keyboard. 1 Check whether the signal cable is plugged in and seated properly. Re-plug the signal cable if necessary. 1 Re-boot the computer or video player.
The monitor will not fill the entire screen.	The picture does not fill the height or width of the screen.	<ul style="list-style-type: none"> 1 Due to the non-standard formats of DVDs, the monitor may not show the full screen.

Troubleshooting the Dell™ Soundbar (Optional)

COMMON SYMPTOMS	WHAT YOU EXPERIENCE	POSSIBLE SOLUTIONS
No Sound	Soundbar has power - power indicator is on.	<ul style="list-style-type: none"> 1 Plug the audio line-in cable into the computer's audio out jack. 1 Set all Windows volume controls to their maximum. 1 Play some audio content on the computer (i.e., audio CD, or MP3). 1 Turn the volume up. 1 Clean and reseat the audio line-in plug. 1 Test the Soundbar using another audio source (i.e., portable CD player).
Distorted Sound	Computer's sound card is used as the audio source.	<ul style="list-style-type: none"> 1 Clear any obstructions between the Soundbar and the user. 1 Confirm that the audio line-in plug is completely inserted into the jack of the sound card. 1 Set all Windows volume controls to their midpoints. 1 Decrease the volume of the audio application.

		<ul style="list-style-type: none"> 1 Turn the volume down. 1 Clean and reseal the audio line-in plug. 1 Troubleshoot the computer's sound card. 1 Test the Soundbar using another audio source (i.e., portable CD player).
Distorted Sound	Other audio source is used.	<ul style="list-style-type: none"> 1 Clear any obstructions between the Soundbar and the user. 1 Confirm that the audio line-in plug is completely inserted into the jack of the audio source. 1 Decrease the volume of the audio source. 1 Turn the volume down. 1 Clean and reseal the audio line-in plug.
Unbalanced Sound Output	Sound from only one side of Soundbar	<ul style="list-style-type: none"> 1 Clear any obstructions between the Soundbar and the user. 1 Confirm that the audio line-in plug is completely inserted into the jack of the sound source. 1 Set all Windows audio balance controls (L-R) to their midpoints. 1 Clean and reseal the audio line-in plug. 1 Troubleshoot the computer's sound card. 1 Test the Soundbar using another audio source (i.e., portable CD player).
Low Volume	Volume is too low	<ul style="list-style-type: none"> 1 Clear any obstructions between the Soundbar and the user. 1 Turn the volume up to its maximum level. 1 Set all Windows volume controls to their maximum. 1 Increase the volume of the audio application. 1 Test the Soundbar using another audio source (i.e., portable CD player).

[Back to Contents Page](#)